

Hybrid Wi-Fi and PLC network for efficient e-health communication in hospitals: a prototype

Shafi Ullah Khan¹, Sana Ullah Jan², Taewoong Hwang¹, In-Soo Koo¹

¹Multimedia Communication Systems Laboratory, Department of Electrical Electronics and Computer Engineering, University of Ulsan, South Korea

²School of Computing, Edinburgh Napier University, Edinburgh EH10 5DT, United Kingdom

Article Info

Article history:

Received Nov 20, 2022

Revised Jul 12, 2023

Accepted Sep 12, 2023

Keywords:

Communications

E-health

Hybrid broadband

Medical applications

Power line communication

ABSTRACT

E-health is being adapted in modern hospitals as a significant addition to the existing healthcare services. To this end, modern hospitals urgently require a mobile, high-capacity, secure, and cost-effective communication infrastructure. In this paper, we explore potential applications of a hybrid broadband power line communication (PLC) and Wi-Fi in an indoor hospital scenario. It utilizes the existing power line cables and Wi-Fi plug-and-play devices for indoor broadband communication. Broadband power line (BPL) adaptors with Wi-Fi outputs are used to build an access network in hospitals, particularly in areas where the wireless router signal is poor. The Tenda PH10 AV1,000 AC Wi-Fi power line adapter is a set of BPL adaptors that offer operational bandwidth of up to 1,000 Mbps. These adaptors are based on the HomePlug AV2 protocol and can provide a data rate up to 200 Mbps on the physical layer. An experiment using the PLC Wi-Fi kit is carried out to show that a Wi-Fi and PLC hybrid network is the best candidate to provide wide range of practical applications in a hospital including, but not limited to, telemedicine, electronic medical records, early-stage disease diagnosis, health management, real-time monitoring, and remote surgeries.

This is an open access article under the [CC BY-SA](https://creativecommons.org/licenses/by-sa/4.0/) license.



Corresponding Author:

In-Soo Koo

Multimedia Communication Systems Laboratory

Department of Electrical Electronic and Computer Engineering, University of Ulsan

Ulsan, South Korea

Email: iskoo@ulsan.ac.kr

1. INTRODUCTION

Smart hospitals are emerging trends that aims to give new services to end users, such as telemedicine, electronic medical record, health knowledge management, live monitoring, and remote surgeries [1]–[3]. To provide these services, a communication network with mobile access, flexible data dissemination, and high data transfer capabilities is needed [4]. Due to the nature of the medical data, the transmission networks also need to offer throughput and a quality of service (QoS) guarantee. Nowadays, healthcare sectors are utilizing communication and networking technology in Tele-healthcare applications to provide patients with health-related services. Local area network (LAN), radio frequency (RF), ZigBee, and wide area network (WAN) are some of the most recent technologies to be utilized for aiding, treating, and monitoring patients in real time [5], [6]. These wireless technologies, for example, are now the most widely used technologies for smart hospital applications. However, there are various issues with signal dispersion and coverage range across greater regions [7], [8]. For instance, RF and Bluetooth based devices have limits when used in regions with concrete walls and surroundings [9], [10]. In addition, ethernet-based systems are inflexible and costly to set up in multi-story hospital complexes. To address these challenges, a hybrid

network is needed that integrates the most used wireless technology with wired technology to minimize costs and complexity. Power line communication has been extensively employed in recent years to develop broadband networks with high data transmission rates based on power grids [11], [12]. Power line communication (PLC) technology is increasingly used to provide high-speed broadband connectivity with minimal infrastructure costs. One major benefit of using PLC networks is the ability to reuse existing electrical wiring for communication, making it an attractive option for smart grid applications. As a result, research in this field is extensive. Additionally, smart city [13], [14] in-home automation [15], [16] and telemetry [11] applications can also take advantage of this technology, as it eliminates the need for new cabling and avoids wireless propagation issues. Furthermore, PLC technology has demonstrated its efficiency and effectiveness in a wide range of applications, including both broadband (BB) and narrowband (NB) communication. With the growing popularity of IoT smart homes and the demand for seamless connectivity, the plug-and-play extenders based on PLC technology are becoming increasingly popular in the market. These devices offer a simple and easy installation process, providing users with a convenient and reliable solution for extending their home networks [17], [18].

PLC technology is a promising solution for modern telecommunication providers to overcome various challenges, including achieving advantages in a shorter time [19]. One of the earliest attempts to utilize home's electrical wiring to transfer information between household devices was the consumer electronic bus (CE bus) power-line carrier technology [20]. The development of a high-speed PLC standard began with the establishment of the data networking subcommittee R7.3 by the consumer electronics association towards the end of 1999 [21]. The primary goal of PLC technology is to achieve data speeds of up to 20 Mbit/s over power-line connections. To ensure that this technology coexists with existing devices that use home power lines for communication, the HomePlug Alliance was established, which aimed to develop a low-cost technology [19]. This technology leverages the existing powerline to provide ethernet-class data speeds at any power outlet. The data rates have increased significantly with the advancement of signal processing and modulation techniques [22]. As a result, several businesses and commercial infrastructures worldwide have established broadband internet access and building networks using PLC technology. In addition to that, PLC networking offers advantages beyond home and building networks, including communication in transport systems that already have electrical deployment [23]. Therefore, PLC networks have been studied for in-vehicle communication as well. However, the use of PLC networks is not limited to these applications.

PLC networks have been proposed for various applications, including robotics [24], authentication, security systems in mining [25], health monitoring [26], [27] and inductive coupling [28], [29]. The broad range of potential applications and associated issues has attracted significant attention from the scientific community and industry, leading to numerous solutions and various regulation and standardization activities. In this paper, we investigate the feasibility of a hybrid broadband power line and Wi-Fi communication system in indoor hospital settings. The proposed system utilizes existing power line cables and Wi-Fi plug-and-play devices for indoor broadband connectivity. Broadband power line (BPL) adaptors with Wi-Fi outputs are used to construct an access network in hospitals, particularly in areas with weak wireless router signals. We demonstrate through a laboratory experiment using the PLC Wi-Fi kit that a Wi-Fi and PLC hybrid network is well-suited for practical applications in a hospital context, including telemedicine, e-medical records, health knowledge management, live monitoring, and remote surgeries.

The remainder of this paper is organized as follow: section 2 describes the overview of network architecture and basic parameters of used equipment. Section 3 shows the performance analysis and comparison of measured transmission rate for Wi-Fi and PLC (broad band over powerlines). Section 4 describes the applications and features of the hybrid system and finally, section 5 concludes the paper.

2. NETWORK STRUCTURE

As in the hospital environment certain medical data must be transferred and accessed across different units. The hybrid network architecture must have the ability to provide flexible network connectivity. To ensure optimal performance, the diagnostic data from network devices should be taken into consideration along with the service requirements of each medical application. In this hospital network, we utilized the two most widely used technologies - Wi-Fi and PLC - to build the access network. Our focus was on the access network characteristics created using the AV1000 Gigabit power line adapter kit. Specifically, in the hospital scenario illustrated in Figure 1, the Wi-Fi serves as the access point and is connected via ethernet cable to the Tenda PH10 AV1000 AC Wi-Fi power line adapter Tenda PLC Master (PA3) that is connected to the main distribution panel of the hospital electrical network. This master router spreads the signal via power lines to the PLC/Wi-Fi outlets connected to the same electrical network where the connected PLC Slaves catches the data signal and deliver it to the internet devices for telemedicine, hospital management, and remote surgical equipment. The high-end powerline adapter kit, (Tenda PH10 AV1000 AC

Wi-Fi power line adapter) is a plug and play device that increases network coverage to the Hospital departments and other locations where the router's wireless signal cannot reach.

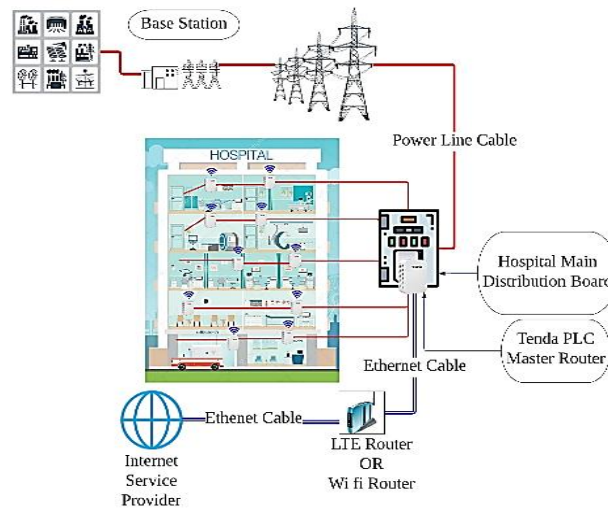

Figure 1. Hospital network design

The powerline adapter kit includes two devices: AV1000 Gigabit powerline adapter and AV1000 AC Wi-Fi powerline extender, as shown in Figures 2(a) and (b) respectively. Tenda powerline adapter uses HomeplugAV2 technology standards, which supports multiple input multiple output (MIMO) signaling with beamforming. This feature improves network coverage throughout the hospital, particularly on high attenuated channels [20]. Additionally, MIMO allows transmission on any two-wire pair within the three-wire configuration of line, neutral, and protective earth. The kit also offers extended frequency bands and efficient notching, providing a maximum throughput of 1,000 Mbps on powerline and up to 200 Mbps on wireless at the physical layer. Tenda PH10 AV1000 AC Wi-Fi power line kit supports all modern networking standards up to 802.11ac. The adaptor kit utilizes AC650 dual-band Wi-Fi technology, ensuring speeds of 433 Mbps on 5 GHz band and 200 Mbps on the 2.4 GHz band [21]. The AV1000 AC Wi-Fi powerline adapter features an ethernet port for connecting it to the wireless or Wi-Fi router, while the AV1000 AC Wi-Fi powerline extender has an additional gigabit ethernet port for stable connections with wired devices such as remote surgical devices, telemedicine equipment, printer, TV, HD set-top box, and so on [22].

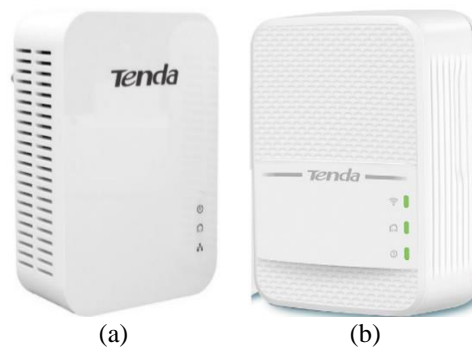

Figure 2. Tenda PH10 AV1000 AC Wi-Fi powerline extender kit: (a) Tenda PA3 adapter and (b) Tenda PLC Slave (PA7) extender

The Tenda PH10 AV1000 AC Wi-Fi powerline extender kit comprises the Tenda PA7 extender and a Tenda PA3 powerline adaptor, as shown in Figure 2. It is configured to use the Broadcom BCM47189B0 Chip in 2×1×1:1 mode. The broadcom BCM47189B0 Chip can be seen in Figure 3. Also, the device uses Broadcom BCM60350 as the HomePlug controller. The RAM configuration is 1 Gb (64 M × 16) on Winbond chipset

W631GG6KB -15. The AV1000 AC Wi-Fi powerline extender kit is a set of PLC adapters that offer support for all modern networking standards from 802.11a to 802.11ac for 2.4 GHz and 5 GHz bandwidth with theoretical speed of 1,000 Mbps on physical layer with 5 GHz band (433 Mbps) and 2.4 GHz band (200 Mbps). The maximum power consumption of PA7 extender is 8.4 W whereas the standby power is 4.7 W. Similarly, the maximum power consumption of PA3 adapter is 3.2 W and the minimum is 0.36 W. The input power ranges from 100 V to 240 V for 50/60 Hz power frequency. The Tenda PH10 AV1000 AC Wi-Fi power line adaptor kit makes the internet available to any area of a hospital building by sharing it wired or wireless with all internet devices within the hospital. The unified network can maintain stable connectivity so, the network created this way can support seamless video streaming, telemedicine, and remote surgeries, for hospital environment.

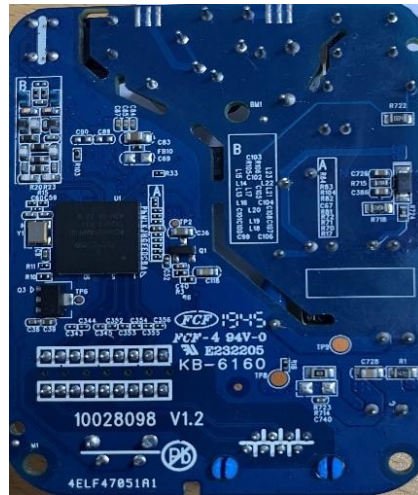

Figure 3. Broadcom BCM47189B0 chip

2.1. System model

A system model was created to test the performance of the hybrid system in a laboratory. A PLC Master was connected to the ipTIME AX8008M Wi-Fi router via ethernet cable, which was then connected to a power line cable. We used electrical extension boards to adjust the length in accordance with our requirements and to place the PLC Slaves at the specified location more accurately inside the network. The configuration of the network is shown in Figures 4(a) to (c) for lengths of 10, 30, and 60 meters, respectively. The performance of the system was then analyzed using StarTrinity continuous speed test (CST) setting the download and upload limitations to 1,000 Mbps and 100 Mbps, respectively.

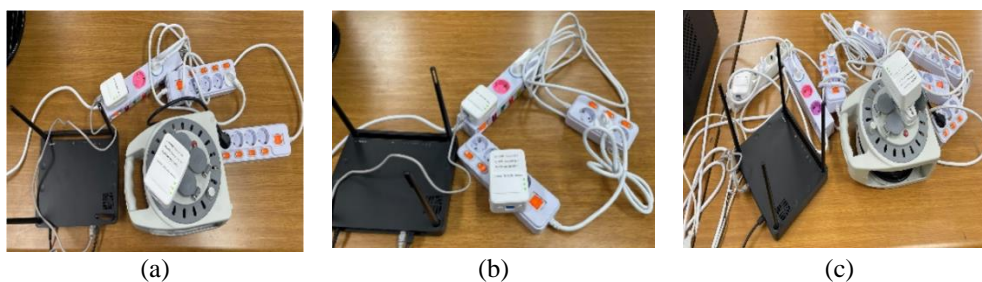

Figure 4. Laboratory system setup for different lengths; (a) 10 meters, (b) 30 meters, and (c) 60 meters

The performance of the system was then analyzed using StarTrinity CST setting the download and upload limitations to 1,000 Mbps and 100 Mbps, respectively. StarTrinity CST is a tool that continuously measures internet speed and can do it for a very long period of time. StarTrinity CST makes upload and download simultaneously and continuously unlike other tools that make upload for a set period of time and downloads for another set period. For such various tests, there may be different speed test results. For example, downloading a file can start at a higher speed, but the speed can drop after some time. Such

degradation of internet quality is usually not detected by regular non-continuous speed tests tools. Round trip time (RTT), packet loss, and jitters can also be measured by the StarTrinity CST. In this experiment, we restricted the upload and download speeds to 100 Mbps and 1,000 Mbps, respectively. Figure 5 shows the measurement speed for 20 seconds while Figure 6 illustrates the home page of the StarTrinity CST.

Time	State	Download (Rx)	Upload (Tx)	Rx packet loss	Tx packet loss	RTT (ping)	Rx loss burst length	Tx loss burst length	Rx instant jitter	Tx instant jitter	Rx RFC3550 jitter	Tx RFC3550 jitter
2022-09-28 17:47:51	up	82.63Mbps/150.00Mbps	100.00Mbps/100.00Mbps	0.00%	0.00%	2.0ms	0.00 packet(s)	0.00 packet(s)	16.8ms	2.8ms	2.1ms	1.1ms
2022-09-28 17:47:50	up	82.72Mbps/150.00Mbps	100.00Mbps/100.00Mbps	0.00%	0.00%	2.0ms	0.00 packet(s)	0.00 packet(s)	20.7ms	3.4ms	3.2ms	1.0ms
2022-09-28 17:47:49	up	82.64Mbps/150.00Mbps	100.00Mbps/100.00Mbps	0.00%	0.00%	6.0ms	0.00 packet(s)	0.00 packet(s)	15.5ms	3.9ms	2.0ms	1.0ms
2022-09-28 17:47:47	up	82.65Mbps/150.00Mbps	100.00Mbps/100.00Mbps	0.00%	0.00%	7.0ms	0.00 packet(s)	0.00 packet(s)	11.3ms	5.2ms	1.6ms	1.0ms
2022-09-28 17:47:46	up	83.39Mbps/150.00Mbps	99.92Mbps/100.00Mbps	0.00%	0.00%	6.0ms	0.00 packet(s)	0.00 packet(s)	13.7ms	3.1ms	1.7ms	0.9ms
2022-09-28 17:47:45	up	82.98Mbps/150.00Mbps	100.00Mbps/100.00Mbps	0.00%	0.00%	6.0ms	0.00 packet(s)	0.00 packet(s)	18.9ms	5.0ms	2.9ms	1.3ms
2022-09-28 17:47:44	up	83.09Mbps/150.00Mbps	100.00Mbps/100.00Mbps	0.00%	0.00%	6.0ms	0.00 packet(s)	0.00 packet(s)	13.9ms	5.8ms	2.5ms	1.4ms
2022-09-28 17:47:43	up	82.80Mbps/150.00Mbps	100.00Mbps/100.00Mbps	0.00%	0.00%	6.0ms	0.00 packet(s)	0.00 packet(s)	18.1ms	3.6ms	2.4ms	1.3ms
2022-09-28 17:47:42	up	82.79Mbps/150.00Mbps	100.00Mbps/100.00Mbps	0.00%	0.00%	7.0ms	0.00 packet(s)	0.00 packet(s)	13.2ms	4.4ms	2.3ms	1.4ms
2022-09-28 17:47:41	up	83.30Mbps/150.00Mbps	100.00Mbps/100.00Mbps	0.00%	0.00%	7.0ms	0.00 packet(s)	0.00 packet(s)	19.7ms	3.7ms	3.6ms	1.1ms
2022-09-28 17:47:40	up	83.57Mbps/150.00Mbps	100.00Mbps/100.00Mbps	0.00%	0.00%	7.0ms	0.00 packet(s)	0.00 packet(s)	33.8ms	4.2ms	4.6ms	1.2ms
2022-09-28 17:47:39	up	83.14Mbps/150.00Mbps	100.00Mbps/100.00Mbps	0.00%	0.00%	7.0ms	0.00 packet(s)	0.00 packet(s)	29.6ms	4.2ms	4.2ms	1.2ms
2022-09-28 17:47:38	up	83.14Mbps/150.00Mbps	100.00Mbps/100.00Mbps	0.00%	0.00%	6.0ms	0.00 packet(s)	0.00 packet(s)	24.5ms	3.3ms	3.5ms	1.0ms
2022-09-28 17:47:37	up	82.70Mbps/150.00Mbps	100.00Mbps/100.00Mbps	0.00%	0.00%	6.0ms	0.00 packet(s)	0.00 packet(s)	25.7ms	4.5ms	4.0ms	1.0ms
2022-09-28 17:47:36	up	83.17Mbps/150.00Mbps	100.00Mbps/100.00Mbps	0.00%	0.00%	7.0ms	0.00 packet(s)	0.00 packet(s)	26.0ms	6.9ms	3.8ms	1.5ms
2022-09-28 17:47:35	up	82.63Mbps/150.00Mbps	100.00Mbps/100.00Mbps	0.00%	0.00%	7.0ms	0.00 packet(s)	0.00 packet(s)	33.8ms	4.6ms	4.7ms	1.1ms
2022-09-28 17:47:34	up	83.57Mbps/150.00Mbps	100.00Mbps/100.00Mbps	0.00%	0.00%	7.0ms	0.00 packet(s)	0.00 packet(s)	38.5ms	4.1ms	5.3ms	0.9ms
2022-09-28 17:47:33	up	83.13Mbps/150.00Mbps	100.00Mbps/100.00Mbps	0.00%	0.00%	7.0ms	0.00 packet(s)	0.00 packet(s)	21.4ms	5.0ms	3.7ms	1.0ms
2022-09-28 17:47:32	up	83.15Mbps/150.00Mbps	100.00Mbps/100.00Mbps	0.00%	0.00%	7.0ms	0.00 packet(s)	0.00 packet(s)	26.9ms	12.6ms	4.6ms	1.7ms
2022-09-28 17:47:31	up	83.12Mbps/150.00Mbps	100.00Mbps/100.00Mbps	0.00%	0.00%	8.0ms	0.00 packet(s)	0.00 packet(s)	19.3ms	4.2ms	3.3ms	0.9ms

Figure 5. Measurement results

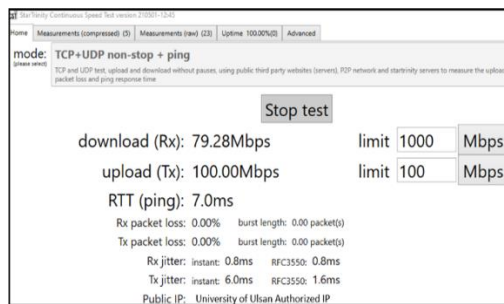

Figure 6. StarTrinity CST home page layout

3. PERFORMANCE ANALYSIS OF THE HYBRID NETWORK OF WI-FI AND PLC

In order to test the performance at various locations, a hybrid PLC and Wi-Fi network was created in the university laboratory. The network structure is depicted in block diagram shown in Figure 7. We connected a Tenda PA3 by ethernet cable to the ipTIME AX8008M Wi-Fi router, which serves as a network access point, and then to the internet service provider (ISP). After that, we linked the Tenda PA7 to the Tenda PA3 via electrical power line extensions at three different distances i.e., 10, 30, and 60 meters, and we individually analyzed the results. Figure 8 shows the measurement points and physical distribution of the extenders. The Tenda PA3 transmits the signal via power lines throughout the electrical network and the Tenda PA7 extenders catch the transmitted signal and spread it to the end devices where it can be used for different hospital applications. We performed the experiments by considering the 3 points namely, point 3, point 2 and point 5 that are located at distance 10, 30, and 60 meters respectively. The access point is situated at point A. A Lenovo G50- 80 laptop and StarTrinity software is used to measure the different parameters of the network. StarTrinity CST measures the different parameters of the network continuously from where a “.CSV” file can be generated to extract different features of the network. For plotting we used Matplotlib Python library.

3.1. Throughput measurement

We set up the Tenda PA7 Wi-Fi extender in 5G mode and operated it at points 3, 2, and 5 individually in order to assess the throughput at various locations. To create a “.CSV” file for further analysis, we continually measured the bit rate for 150 seconds using StarTrinity CST. Overall, Figure 9 shows that the bit rate drops gradually when the PA7 extender is moved away from the main router. First,

the PA7 extender was connected to the master router via power-line cable at 10 meters. The graph depicts that the average throughput was calculated to be 88.20 Mbps, while the lowest and highest speeds were recorded at 77.14 and 94.91 Mbps, respectively. After that, we extended the power-line cable to point 2, which was 30 meters distant from the main router, and connected the PA7 to the PA3 adapter there. We then monitored the data rate for an additional 150 seconds. It was seen that the lowest and maximum speeds decreased to 75.25 Mbps, respectively, and that of the average speed reduced to 80 Mbps. Finally, when the PA7 extender was extended to point 5. The average bit rate decreased further to 77.12 Mbps, with the lowest being 62.35 Mbps and the maximum being 77.01 Mbps.

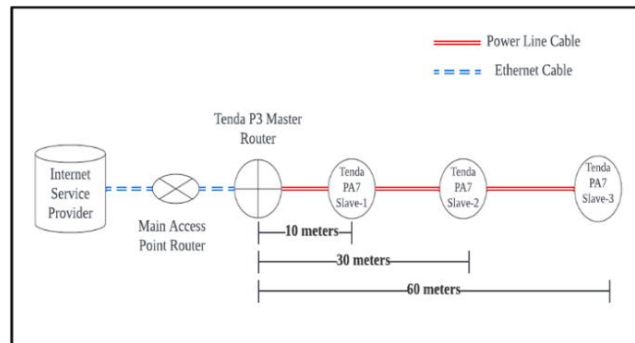

Figure 7. System model

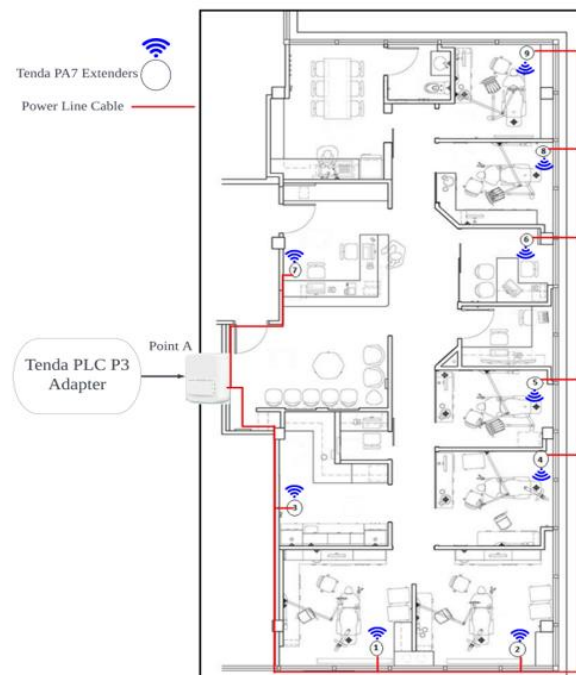

Figure 8. Location points distribution in a hospital building

3.2. Effect of load on Tenda PA7 powerline extender

We initially evaluated the Ph10 power line adapter kit's performance in lines with no load, after which we attached some load to the electrical network and retested the performance. The main access router was connected to the Tenda. We initially evaluated the Ph10 power line adapter kit's performance in lines with no load, after which we attached some load to the electrical network and retested the performance. The main access router was connected to the Tenda PA3, which was then linked to the Tenda PA7. As illustrated in Figure 10(a), the configuration was created for a single point where the Tenda PA7 and Tenda PA3 were placed 50 meters apart and a 1400 watt load was injected into the network. The real laboratory set-up is depicted in Figure 10(b), and performance in both scenarios was examined. In order to figure out how the load impacted the extender's performance; the throughput was monitored for 150 seconds. The graph in Figure 11 shows that

the first case's average data rate was 70.7 Mbps, with a lowest of 61.45 Mbps and a highest of 76.35 Mbps. However, the minimum and maximum data rates declined to 48.98 Mbps and 73.52 Mbps, respectively, while the average rate decreased to 65.97 Mbps.

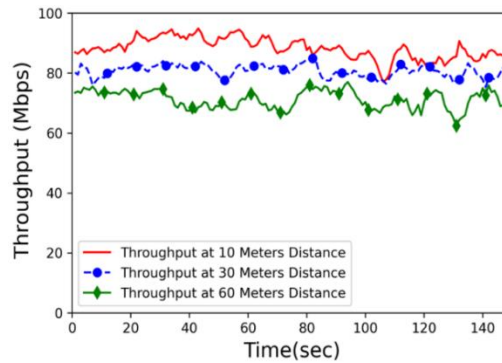

Figure 9. Throughput

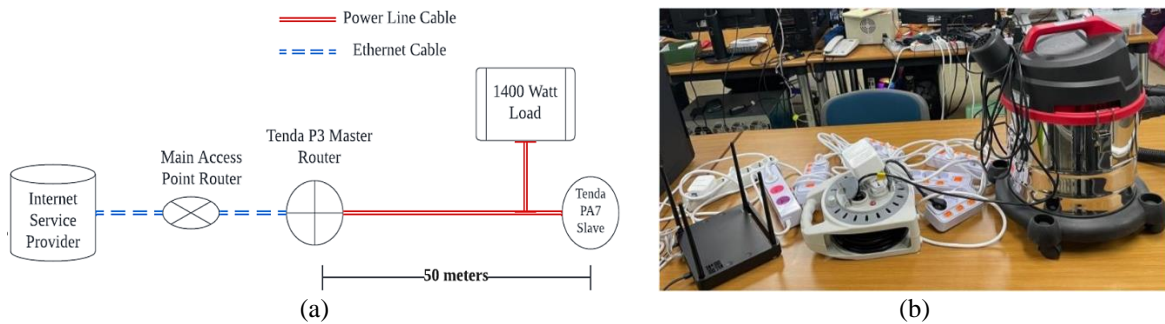

Figure 10. 1400 watt load connection; (a) block diagram and (b) laboratorial setup

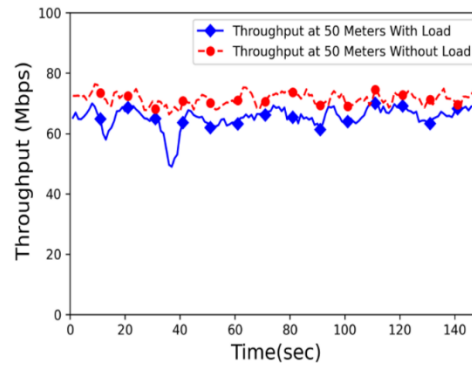

Figure 11. Performance of TENDA P10 with and without load

3.3. Signal strength analysis

To analyze the received signal strength a Wi-Fi analyzer Android application was used. Figure 12(a) illustrates that at 20 meters distance the main router's signal strength was below -60 dBm, however, this strength was above -30 dBm for the Tenda PA7 PLC extender. Then, we extended the powerline extension to 25 meters and analyzed the signal strength of the Tenda P10 Tool Kit and the main router's signal at that point. The signal strength of the main router's signal was observed to be below -90 dBm compared to the Tenda PA10 Tool Kit's signal strength which was just below -40 dBm as shown in Figure 12(b). After that, we further extended the extension to 30 meters distance. Figure 12(c) shows that at 30 meters distance the main access point router has no signal power to be shown on mobile application but the Tenda P10 toolkit had a signal strength of above -30 dBm.

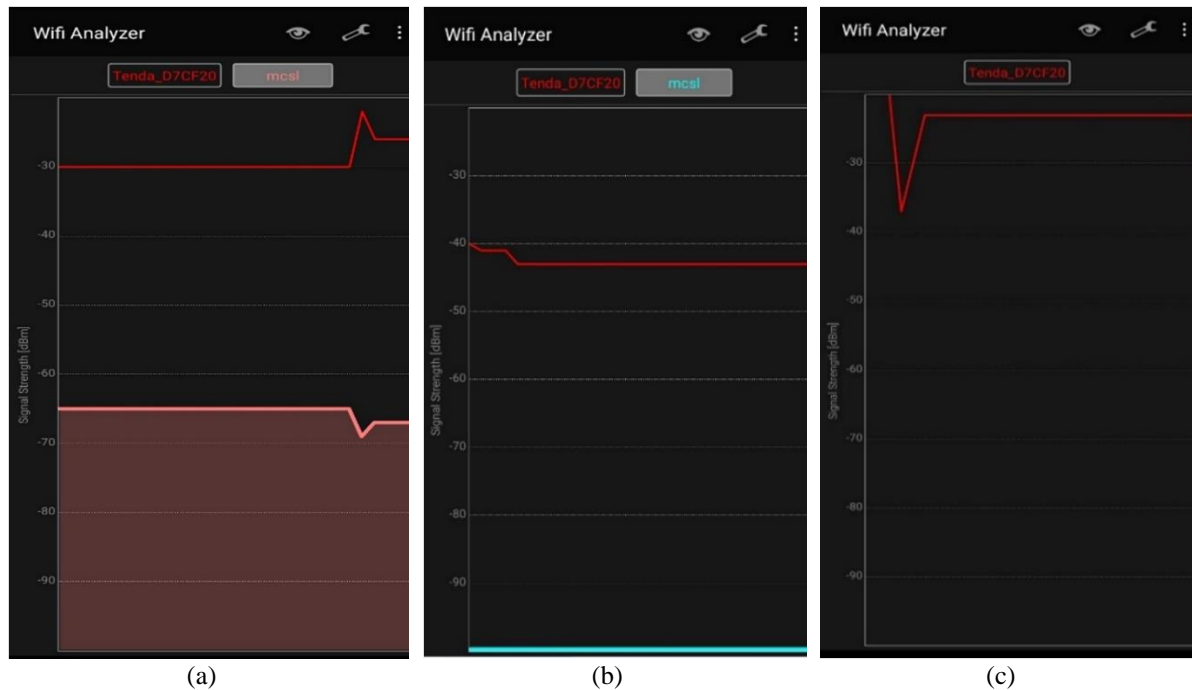

Figure 12. Signal strength analysis at different distances; (a) 20 meters, (b) 25 meters, and (c) 30 meters

4. APPLICATIONS AND FEATURES OF THE HYBRID SYSTEM

4.1. Features

The hybrid system integrates the reliability of PLC with the bandwidth capabilities of Wi-Fi, establishing a comprehensive solution designed for the demanding requirements of hospital infrastructures. Specifically, this system utilizes the existing electrical wiring for stable PLC connectivity, thereby mitigating issues related to wireless signal interference common in clinical settings. Simultaneously, it incorporates Wi-Fi's flexibility and speed, facilitating seamless mobile data transmission critical for real-time medical applications. This dual-faceted approach ensures an optimized communication framework that supports a wide range of hospital operations, from telemedicine to patient data management.

4.1.1. Locatable

The hybrid system, leveraging the widespread presence of electrical wires, can be effectively utilized for indoor positioning. The PLC network can also be used by the currently installed trackers or monitors to provide both power and communication. This system has the potential to provide a diverse range of indoor location-based services utilizing both PLC and Wi-Fi technologies. These services may include indoor navigation, first aid assistance, and other useful features.

4.1.2. Mobility

The Tenda PLC P10 powerline kit offers exceptional mobility due to its plug-and-play design and the ubiquity of electrical wiring. Since the PA7 extenders can be easily relocated within a single electrical network, they provide users with the flexibility to position the Wi-Fi extension point in any location as their connectivity needs change. This portability is particularly advantageous in dynamic environments where user demand for network access can shift rapidly, ensuring that robust internet coverage is maintained without the need for complex reconfiguration or installation processes.

4.1.3. Radiation free

In a hospital environment, minimizing interference with sensitive medical equipment such as electrocardiogram (ECG) and magnetic resonance imaging (MRI) is crucial. Traditional 3G/4G wireless communications may pose a risk due to electromagnetic interference, which can disrupt the functioning of such equipment and potentially harm patients with specific vulnerabilities. In contrast, the PLC system transmits data at high rates through PLC cables without emitting harmful radiation, making it a safer alternative for hospital settings where maintaining a radiation-free environment is essential for the protection of both patients and equipment.

4.1.4. High capacity

The hybrid setup has the capability of achieving a data rate of up to 1,000 s. This results in a significant increase in the data rate of the entire system. Such a hybrid system is suitable for hospitals where there are multiple users and a need for continuous or burst massive data transmission and is also capable of supporting medical video conferences, transferring medical data and images of patients, and fulfilling other related requirements.

4.1.5. Data security

The hybrid system's reliance on power line cables as its communication backbone inherently enhances data security. This configuration restricts data transmission to within the confines of the physical electrical network, greatly reducing the susceptibility to external breaches. As a result, when data is transferred between different areas in the same network, it remains safeguarded against interception, ensuring that sensitive information is securely contained within the hospital's infrastructure.

4.2. Possible applications

The practicality and versatility of the proposed system are evident after a detailed evaluation of its features. To demonstrate its potential, we have conducted a lab-based experiment, as illustrated in Figure 4, showcasing the system's capabilities in a controlled environment. The applications of this hybrid system can be broadly classified into two categories, reflecting its diverse utility. Firstly, it can be used for critical data transmission within healthcare settings, where reliable and secure communication is paramount. Secondly, its adaptability makes it suitable for areas requiring rapid deployment and reconfiguration, such as temporary medical facilities or emergency response units. This bifurcation underscores the system's adaptability to different operational needs within the healthcare sector.

4.2.1. Medical uses

The system we propose is uniquely capable of supporting a wide range of medical services, thanks to its integration with a robust network protocol. These services encompass several critical aspects of modern healthcare. Firstly, it facilitates patient data record maintenance, ensuring that patient histories and treatment plans are securely stored and easily accessible to healthcare providers. Secondly, it enhances data management and transfer, enabling efficient and swift sharing of medical information within the healthcare network. Additionally, the system supports remote patient monitoring, allowing for the tracking of vital signs in real-time, which is crucial for patients with chronic conditions or those in post-operative care.

4.2.2. Non-medical uses

The proposed hybrid system's versatility extends to various non-medical services, enhancing operational efficiency and user experience. It supports emergency broadcasting for rapid information dissemination, manages indoor navigation for guiding visitors in large facilities, and transmits multimedia content for entertainment. Furthermore, it integrates with smart community devices, controlling amenities like smart clocks and LED lights, and facilitates online attendance systems, demonstrating its broad applicability beyond healthcare.

5. CONCLUSION

In this paper, we explore potential applications for a hybrid broadband power line and Wi-Fi communication system in indoor hospital scenarios. The system utilizes the already existing power line cables and Wi-Fi plug-and-play devices for indoor broadband communication. Moreover, we discussed the effect of load and powerline cable length on the Tenda PH10 AV1000 AC Wi-Fi powerline extender kit. First, we transferred the 100 Mbps data from master router to the slaves placed at distances of 10, 30, and 60 meters and calculated the download Mbps. It was concluded that the data rate decreased slightly when the length of the power line cable increases. Also, the load also has a minimal effect on data rate when compared with the no load power line. However, the proposed hybrid system has several excellent features, including, high capacity, strong privacy and security, and impending availability. We do believe that using a hybrid system in a hospital setting can emphasize its benefits, and we are hopeful that doing so would increase interest in e-health research groups while also supporting applications for indoor hospitals. The selected PLC and Wi-Fi kit incorporates all the current Wi-Fi technologies and implements the widely adopted HomePlug AV2 specification for broadband power line systems. The achieved results demonstrate the feasibility of using these devices for indoor applications in hospitals, making them a suitable choice for building access networks. In our future work we are planning to design smart beds for intensive care units (ICU) using power line and Wi-Fi standards.

ACKNOWLEDGEMENTS

This work was supported in part by the ICT R&D innovation voucher conducted in 2022 with the support of the institute of information and communications technology planning and evaluation (IITP), funded by the government's ministry of science and ICT.(No. 2022-0-00805, Development of wired/wireless communication technology for installation safety communication network for workers in shaded areas of building ships). In addition, this result was supported by the Regional Innovation Strategy (RIS) through the National Research Foundation of Korea (NRF) funded by the Ministry of Education (MOE) (2021RIS-003).



REFERENCES

- [1] R. Dwivedi, D. Mehrotra, and S. Chandra, "Potential of internet of medical things (IoMT) applications in building a smart healthcare system: A systematic review," *Journal of Oral Biology and Craniofacial Research*, vol. 12, no. 2, pp. 302–318, Mar. 2022, doi: 10.1016/j.jobcr.2021.11.010.
- [2] F. Jamil, S. Ahmad, N. Iqbal, and D. H. Kim, "Towards a remote monitoring of patient vital signs based on iot-based blockchain integrity management platforms in smart hospitals," *Sensors (Switzerland)*, vol. 20, no. 8, Apr. 2020, doi: 10.3390/s20082195.
- [3] S. Razdan and S. Sharma, "Internet of medical things (IoMT): Overview, emerging technologies, and case studies," *IETE Technical Review (Institution of Electronics and Telecommunication Engineers, India)*, vol. 39, no. 4, pp. 775–788, May 2022, doi: 10.1080/02564602.2021.1927863.
- [4] A. Winter *et al.*, "Smart medical information technology for healthcare (SMITH)," *Methods of information in medicine*, vol. 57, no. S 01, Jul. 2018, doi: 10.3414/ME18-02-0004.
- [5] S. C and S. Fahmi, *Application of power line communication in healthcare for ECG and EEG monitoring*. Proc. Of Int. Conf. on Advances in Power Electronics and Instrumentation Engineering, 2013.
- [6] Z. Fan, R. Haines, and P. Kulkarni, "M2M communications for E-health and smart grid: An industry and standard perspective," *IEEE Wireless Communications*, vol. 21, no. 1, pp. 62–69, Feb. 2014, doi: 10.1109/MWC.2014.6757898.
- [7] D. Dietrich, D. Bruckner, G. Zucker, and P. Palensky, "Communication and computation in buildings: A short introduction and overview," *IEEE Transactions on Industrial Electronics*, vol. 57, no. 11, pp. 3577–3584, Nov. 2010, doi: 10.1109/TIE.2010.2046570.
- [8] H. A. H. Alobaidy, M. Jit Singh, M. Behjati, R. Nordin, and N. F. Abdullah, "Wireless transmissions, propagation and channel modelling for IoT technologies: Applications and challenges," *IEEE Access*, vol. 10, pp. 24095–24131, 2022, doi: 10.1109/ACCESS.2022.3151967.
- [9] S. J. Danbatta and A. Varol, "Comparison of Zigbee, Z-Wave, Wi-Fi, and bluetooth wireless technologies used in home automation," in *7th International Symposium on Digital Forensics and Security, ISDFS 2019*, Jun. 2019, doi: 10.1109/ISDFS.2019.8757472.
- [10] R. Sukanesh, S. P. Rajan, S. Vijayprasad, S. J. Prabhu, and P. Subathra, "GSM based ECG tele-alert system," in *International Conference on Innovative Computing Technologies, MKCE-ICICT 2010*, Feb. 2010, doi: 10.1109/ICINNOVCT.2010.5440084.
- [11] G. López *et al.*, "The role of power line communications in the smart grid revisited: Applications, challenges, and research initiatives," *IEEE Access*, vol. 7, pp. 117346–117368, 2019, doi: 10.1109/ACCESS.2019.2928391.
- [12] E. Kabalci and Y. Kabalci, *Smart grids and their communication systems*. Springer Singapore, 2019, doi: 10.1007/978-981-13-1768-2.
- [13] J. Slacik, P. Mlynek, M. Ruzs, P. Musil, L. Benesl, and M. Ptacek, "Broadband power line communication for integration of energy sensors within a smart city ecosystem," *Sensors*, vol. 21, no. 10, May 2021, doi: 10.3390/s21103402.
- [14] W. Ejaz and A. Anpalagan, "Internet of things for smart cities: Overview and key challenges," in *SpringerBriefs in Electrical and Computer Engineering*, Springer International Publishing, 2019, pp. 1–15, doi: 10.1007/978-3-319-95037-2_1.
- [15] R. Dotihal, A. Soporli, A. Muku, N. Deochake, and D. T. Varpe, "Smart homes using alexa and power line communication in IoT," in *Lecture Notes on Data Engineering and Communications Technologies*, vol. 15, Springer Singapore, 2019, pp. 241–248, doi: 10.1007/978-981-10-8681-6_23.
- [16] T. M. Fernández-Caramés, "An intelligent power outlet system for the smart home of the internet of things," *International Journal of Distributed Sensor Networks*, vol. 2015, no. 11, Nov. 2015, doi: 10.1155/2015/214805.
- [17] P. Mlynek, Z. Hasirci, J. Misurec, and R. Fudjak, "Analysis of channel transfer functions in power line communication system for smart metering and home area network," *Advances in Electrical and Computer Engineering*, vol. 16, no. 4, pp. 51–56, 2016, doi: 10.4316/AECE.2016.04008.
- [18] "Power line communication (PLC) systems," *Global Market Trajectory & Analytics. Global Industry Analysts, Inc.*, 2020.
- [19] O. A. Gonzalez, J. Urminsky, M. Calvo, and L. De Haro, "Performance analysis of hybrid broadband access technologies using PLC and Wi-Fi," in *2005 International Conference on Wireless Networks, Communications and Mobile Computing*, 2005, vol. 1, pp. 564–569, doi: 10.1109/WIRLES.2005.1549470.
- [20] M. H. Shwehdi and A. Z. Khan, "A power line data communication interface using spread spectrum technology in home automation," *IEEE Transactions on Power Delivery*, vol. 11, no. 3, pp. 1232–1237, Jul. 1996, doi: 10.1109/61.517476.
- [21] T. Zahariadis, K. Pramataris, and N. Zervos, "A comparison of competing broadband in-home technologies," *Electronics and Communication Engineering Journal*, vol. 14, no. 4, pp. 133–142, Aug. 2002, doi: 10.1049/ecej:20020401.
- [22] S. Du, S. Chen, W. Peng, and B. Zhao, "An improved power line communication system based on FH-OFDM transmission scheme," in *2022 2nd International Conference on Intelligent Technology and Embedded Systems, ICITES 2022*, Sep. 2022, pp. 1–5, doi: 10.1109/ICITES56274.2022.9943783.
- [23] C. Cano, A. Pittolo, D. Malone, L. Lampe, A. M. Tonello, and A. G. Dabak, "State of the art in power line communications: From the applications to the medium," *IEEE Journal on Selected Areas in Communications*, vol. 34, no. 7, pp. 1935–1952, Jul. 2016, doi: 10.1109/JSAC.2016.2566018.
- [24] E. J. Lima, M. H. S. Bomfim, and M. A. De M. Mourão, "POLIBOT – Power lines inspection robot," *Industrial Robot*, vol. 45, no. 1, pp. 98–109, Jan. 2018, doi: 10.1108/IR-08-2016-0217.
- [25] L. Ranjith, L. Fanai, K. Choeden, S. Kumar, and P. Kumar, "IoT based power line communication in underground coal mines," in *Proceedings of the First International Conference on Advanced Scientific Innovation in Science, Engineering and Technology, ICASISSET 2020, 16-17 May 2020, Chennai, India*, 2021, doi: 10.4108/eai.16-5-2020.2304028.
- [26] W. Ding *et al.*, "A hybrid power line and visible light communication system for indoor hospital applications," *Computers in Industry*, vol. 68, pp. 170–178, Apr. 2015, doi: 10.1016/j.compind.2015.01.006.
- [27] J. Song *et al.*, "Indoor hospital communication systems: An integrated solution based on power line and visible light



- communication,” in *2014 IEEE Faible Tension Faible Consommation, FTFC 2014*, May 2014, doi: 10.1109/FTFC.2014.6828620.
- [28] L. Zhang, X. Liu, and D. Xu, “A novel security monitoring system of coal mine based on power line communication dynamic routing technology,” in *2014 IEEE Industry Application Society Annual Meeting, IAS 2014*, Oct. 2014, doi: 10.1109/IAS.2014.6978461.
- [29] L. G. da S. Costa, A. C. M. de Queiroz, B. Adebisi, V. L. R. da Costa, and M. V. Ribeiro, “Coupling for power line communications: A Survey,” *Journal of Communication and Information Systems*, vol. 32, no. 1, pp. 8–22, 2017, doi: 10.14209/jcis.2017.2.

BIOGRAPHIES OF AUTHORS





Shafi Ullah Khan    received his bachelor’s degree in Electrical Engineering from the University of Engineering and Technology Peshawar, Pakistan, in 2020. He is currently pursuing the M.S. degree in Electrical Engineering with Department of Electrical Electronics and Computer Engineering at University of Ulsan, Ulsan, South Korea. His research interests include power line communication, machine learning, deep learning, and internet of things. He can be contacted at email: 16pwele4945@uetpeshawar.edu.pk.





Sana Ullah Jan    is an experienced researcher with more than 8 years of cutting-edge research and teaching experience in prestigious institutes including the University of The West of Scotland, the University of Ulsan (South Korea) and the University of Lahore (Pakistan). He is currently enrolled as lecturer/assistant professor in Edinburgh Napier University, UK since September 2021. He was previously enrolled as Post-doctoral Research Fellow at the Center of Affective and Human Computing for Smart Environment at the School of Computing, Engineering and Physical Sciences, University of the West of Scotland since September 2020 to August 2021. He has (co) authored more than 20 papers in international journals and peer-reviewed international conference proceedings. His research area is closely related to the artificial intelligence or machine learning-based cyber security and privacy in the internet-of-things, cyber physical systems and e-health, and sensor fault detection, and diagnosis. He can be contacted at email: S.jan@napier.ac.uk.



Taewoong Hwang    received his bachelor’s degree in Electrical Engineering from the University of Ulsan, South Korea, in 2022. He is currently pursuing his master’s degrees in Electrical Engineering with Department of Electrical Electronics and Computer Engineering, at University of Ulsan, South Korea. His research interest includes IoT, embedded system, and M2M. He can be contacted at email: yuio124@naver.com.



In-Soo Koo    received the B.E. degree from Kon-Kuk University, Seoul, South Korea, in 1996, and the M.Sc. and Ph.D. degrees from the Gwangju Institute of Science and Technology (GIST), Gwangju, Korea, in 1998 and 2002, respectively. From 2002 to 2004, he was a research professor at the Ultrafast Fiber-Optic Networks Research Center, GIST. In 2003, he was a Visiting Scholar at the Royal Institute of Science and Technology, Stockholm, Sweden. In 2005, he joined the University of Ulsan, Ulsan, South Korea, where he is currently a full professor. His current research interests include spectrum sensing issues for CRNs, channel and power allocation for cognitive radios (CRs) and military networks, SWIPT MIMO issues for CRs, MAC and routing protocol design for UW-ASNs, and relay selection issues in CCRNs. He can be contacted at email: iskoo@ulsan.ac.kr.